

## Small Signal Schottky Diodes

### Features

- For surface mounted applications
- Low-profile package
- Ideal for automated placement
- Low power loss, high efficiency
- High temperature soldering: 260 °C/10 s at terminals
- Wave and reflow solderable
- AEC-Q101 qualified
- Compliant to RoHS directive 2002/95/EC and in accordance to WEEE 2002/96/EC



RoHS  
COMPLIANT

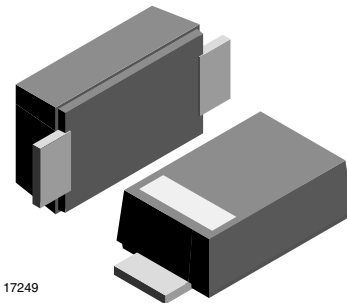

17249

### Mechanical Data

**Case:** DO-219AB (SMF)

**Polarity:** color band denotes cathode end

**Weight:** approx. 15 mg

#### Packaging codes/options:

GS18/10 k per 13" reel (8 mm tape), 50 k/box

GS08/3 k per 7" reel (8 mm tape), 30 k/box

### Parts Table

Part	Ordering code	Marking	Remarks
SL02	SL02-GS18 or SL02-GS08	S2	Tape and reel
SL03	SL03-GS18 or SL03-GS08	S3	Tape and reel
SL04	SL04-GS18 or SL04-GS08	S4	Tape and reel

### Absolute Maximum Ratings

T<sub>amb</sub> = 25 °C, unless otherwise specified

Parameter	Test condition	Part	Symbol	Value	Unit
Maximum repetitive peak reverse voltage		SL02	V <sub>RRM</sub>	20	V
		SL03	V <sub>RRM</sub>	30	V
		SL04	V <sub>RRM</sub>	40	V
Maximum RMS voltage		SL02	V <sub>RMS</sub>	14	V
		SL03	V <sub>RMS</sub>	21	V
		SL04	V <sub>RMS</sub>	28	V
Maximum DC blocking voltage		SL02	V <sub>DC</sub>	20	V
		SL03	V <sub>DC</sub>	30	V
		SL04	V <sub>DC</sub>	40	V
Maximum average forward rectified current	T <sub>tp</sub> = 109 °C		I <sub>F(AV)</sub>	1.1	A
Peak forward surge current 8.3 ms single half sine-wave			I <sub>FSM</sub>	40	A

### Thermal Characteristics

$T_{amb} = 25\text{ °C}$ , unless otherwise specified

Parameter	Test condition	Symbol	Value	Unit
Thermal resistance junction to ambient air <sup>1)</sup>		$R_{thJA}$	180	K/W
Maximum operating junction temperature		$T_j$	125	°C
Storage temperature range		$T_{stg}$	- 55 to 150	°C

Note:

<sup>1)</sup> Mounted on epoxy substrate with 3 mm x 3 mm Cu pads ( $\geq 40\text{ }\mu\text{m}$  thick)

### Electrical Characteristics

$T_{amb} = 25\text{ °C}$ , unless otherwise specified

Parameter	Test condition	Part	Symbol	Min	Typ.	Max	Unit
Instaneous forward voltage	$I_F = 0.5\text{ A}$ <sup>1)</sup>	SL02	$V_F$		0.360	0.385	V
		SL03	$V_F$		0.395	0.43	V
		SL04	$V_F$		0.450	0.51	V
Typical instantaneous forward voltage	$I_F = 1.1\text{ A}$	SL02	$V_F$		0.420		V
		SL03	$V_F$		0.450		V
		SL04	$V_F$		0.530		V
Maximum DC reverse current at rated DC blocking voltage	$T_A = 25\text{ °C}$	SL02	$I_R$			250	$\mu\text{A}$
	$T_A = 100\text{ °C}$	SL02	$I_R$			8	mA
	$T_A = 25\text{ °C}$	SL03	$I_R$			130	$\mu\text{A}$
	$T_A = 100\text{ °C}$	SL03	$I_R$			6	mA
	$T_A = 25\text{ °C}$	SL04	$I_R$			20	$\mu\text{A}$
	$T_A = 100\text{ °C}$	SL04	$I_R$			6	mA

Note:

<sup>1)</sup> Pulse test: 300  $\mu\text{s}$  pulse width, 1 % duty cycle

## Typical Characteristics

$T_{amb} = 25\text{ }^{\circ}\text{C}$ , unless otherwise specified

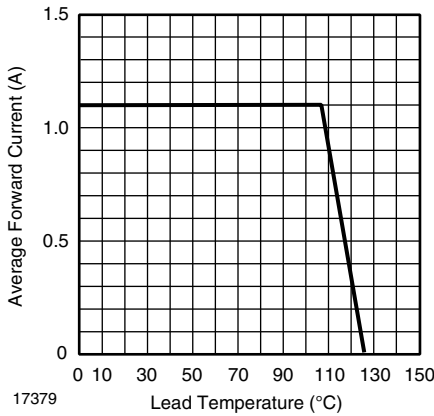

Figure 1. Forward Current Derating Curve

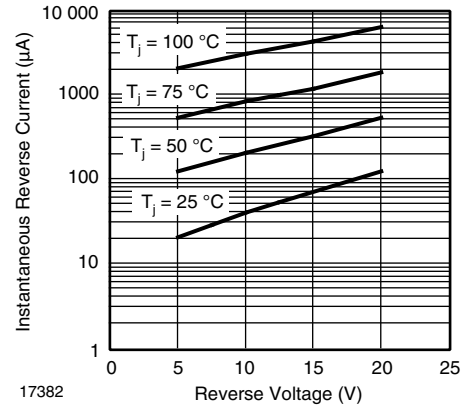

Figure 4. Typical Reverse Current Characteristics - SL02

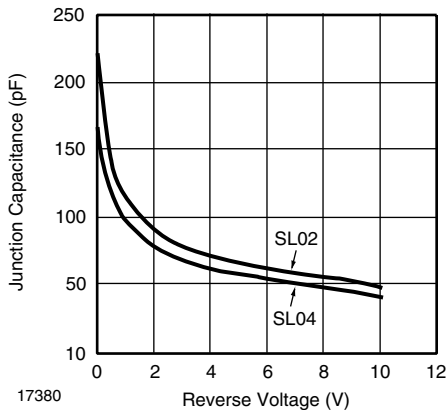

Figure 2. Typical Junction Capacitance

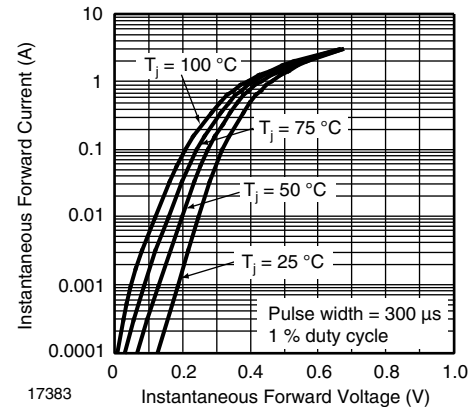

Figure 5. Typical Instantaneous Forward Characteristics - SL03

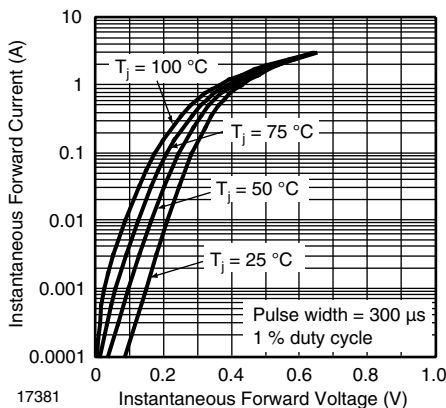

Figure 3. Typical Instantaneous Forward Characteristics - SL02

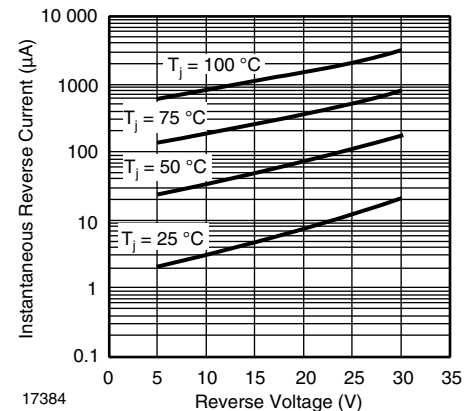

Figure 6. Typical Reverse Current Characteristics - SL03

# SL02, SL03, SL04



Vishay Semiconductors

## Package Dimensions in millimeters (inches): DO-219AB

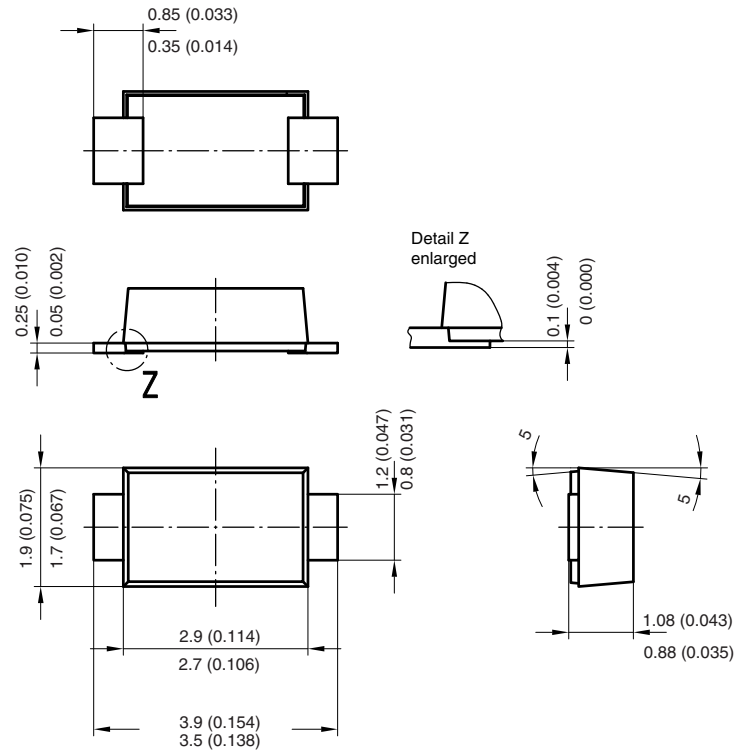

Foot print recommendation:

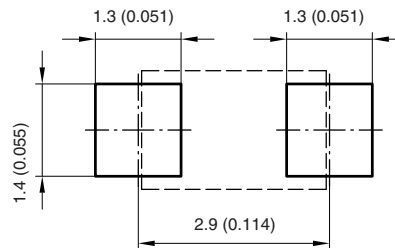

Created - Date: 15. February 2005  
Rev. 3 - Date: 13. March 2007  
Document no.:S8-V-3915.01-001 (4)  
17247

## Blisertape Dimensions for SMF in millimeters

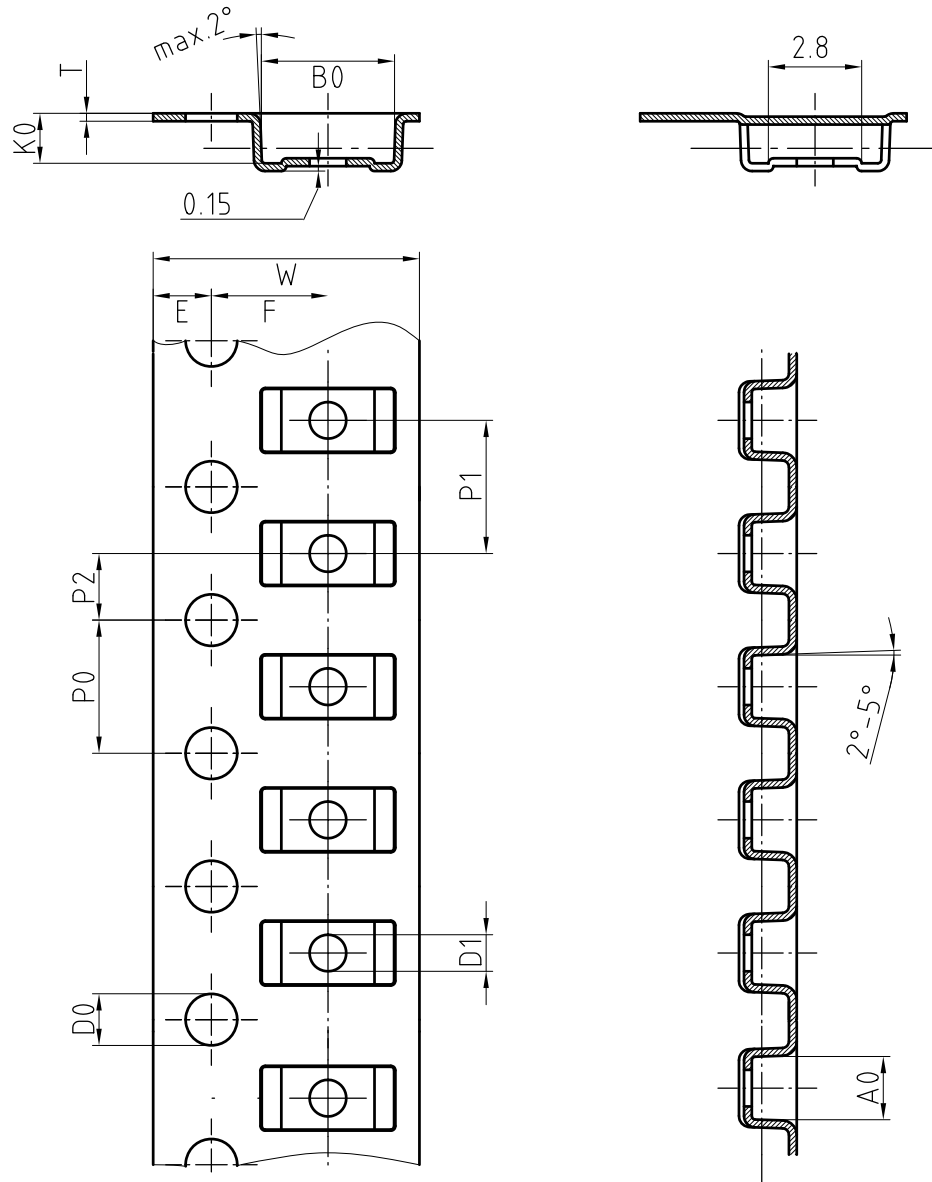

Mat:	A0	B0	K0	W	T	P0	P2	P1	D0	D1	E	F
PS	1.9	4.0	1.5	8.0	0.235	4.0	2.0	4.0	1.5	1	1.75	3.5

Document-No.: S8-V-3717.02-001 (3)

18513



## Disclaimer

All product specifications and data are subject to change without notice.

Vishay Intertechnology, Inc., its affiliates, agents, and employees, and all persons acting on its or their behalf (collectively, "Vishay"), disclaim any and all liability for any errors, inaccuracies or incompleteness contained herein or in any other disclosure relating to any product.

Vishay disclaims any and all liability arising out of the use or application of any product described herein or of any information provided herein to the maximum extent permitted by law. The product specifications do not expand or otherwise modify Vishay's terms and conditions of purchase, including but not limited to the warranty expressed therein, which apply to these products.

No license, express or implied, by estoppel or otherwise, to any intellectual property rights is granted by this document or by any conduct of Vishay.

The products shown herein are not designed for use in medical, life-saving, or life-sustaining applications unless otherwise expressly indicated. Customers using or selling Vishay products not expressly indicated for use in such applications do so entirely at their own risk and agree to fully indemnify Vishay for any damages arising or resulting from such use or sale. Please contact authorized Vishay personnel to obtain written terms and conditions regarding products designed for such applications.

Product names and markings noted herein may be trademarks of their respective owners.